

LINEAR MOSFET

Linear Mosfets are optimized for applications operating in the Linear region where concurrent high voltage and high current can occur at near DC conditions (>100 msec).

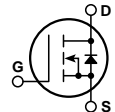

- Higher FBSOA
- Popular SOT-227 Package
- Higher Power Dissipation

MAXIMUM RATINGS

All Ratings: $T_C = 25^\circ\text{C}$ unless otherwise specified.

Symbol	Parameter	APL602J	UNIT
V_{DSS}	Drain-Source Voltage	600	Volts
I_D	Continuous Drain Current @ $T_C = 25^\circ\text{C}$	43	Amps
I_{DM}	Pulsed Drain Current ^①	172	
V_{GS}	Gate-Source Voltage Continuous	± 30	Volts
V_{GSM}	Gate-Source Voltage Transient	± 40	
P_D	Total Power Dissipation @ $T_C = 25^\circ\text{C}$	565	Watts
	Linear Derating Factor	4.52	W/ $^\circ\text{C}$
T_J, T_{STG}	Operating and Storage Junction Temperature Range	-55 to 150	$^\circ\text{C}$
T_L	Lead Temperature: 0.063" from Case for 10 Sec.	300	
I_{AR}	Avalanche Current ^① (Repetitive and Non-Repetitive)	43	Amps
E_{AR}	Repetitive Avalanche Energy ^①	50	mJ
E_{AS}	Single Pulse Avalanche Energy ^④	3000	

STATIC ELECTRICAL CHARACTERISTICS

Symbol	Characteristic / Test Conditions / Part Number	MIN	TYP	MAX	UNIT
BV_{DSS}	Drain-Source Breakdown Voltage ($V_{GS} = 0V, I_D = 250 \mu\text{A}$)	600			Volts
$I_D(\text{ON})$	On State Drain Current ^② ($V_{DS} > I_D(\text{ON}) \times R_{DS}(\text{ON}) \text{ Max}, V_{GS} = 12V$)	43			Amps
$R_{DS}(\text{ON})$	Drain-Source On-State Resistance ^② ($V_{GS} = 12V, 21.5A$)			0.125	Ohms
I_{DSS}	Zero Gate Voltage Drain Current ($V_{DS} = 600V, V_{GS} = 0V$)			25	μA
	Zero Gate Voltage Drain Current ($V_{DS} = 480V, V_{GS} = 0V, T_C = 125^\circ\text{C}$)			250	
I_{GSS}	Gate-Source Leakage Current ($V_{GS} = \pm 30V, V_{DS} = 0V$)			± 100	nA
$V_{GS}(\text{TH})$	Gate Threshold Voltage ($V_{DS} = V_{GS}, I_D = 2.5\text{mA}$)	2		4	Volts

 **CAUTION:** These Devices are Sensitive to Electrostatic Discharge. Proper Handling Procedures Should Be Followed.

DYNAMIC CHARACTERISTICS

Symbol	Characteristic	Test Conditions	MIN	TYP	MAX	UNIT
C_{iss}	Input Capacitance	$V_{GS} = 0V$ $V_{DS} = 25V$ $f = 1 \text{ MHz}$		7600	9000	pF
C_{oss}	Output Capacitance			1280	1810	
C_{rss}	Reverse Transfer Capacitance			620	930	
$t_d(\text{on})$	Turn-on Delay Time	$V_{GS} = 15V$ $V_{DD} = 0.5 V_{DSS}$ $I_D = 43A @ 25^\circ C$ $R_G = 0.6\Omega$		13	26	ns
t_r	Rise Time			24	48	
$t_d(\text{off})$	Turn-off Delay Time			58	87	
t_f	Fall Time			14	17	

THERMAL CHARACTERISTICS

Symbol	Characteristic	MIN	TYP	MAX	UNIT
$R_{\theta JC}$	Junction to Case			.22	°C/W
$R_{\theta JA}$	Junction to Ambient			40	
$V_{Isolation}$	RMS Voltage (50-60 Hz Sinusoidal Waveform From Terminals to Mounting Base for 1 Min.)	2500			Volts
Torque	Maximum Torque for Device Mounting Screws and Electrical Terminations.			10	lb•in

- ① Repetitive Rating: Pulse width limited by maximum junction temperature.
 - ② Pulse Test: Pulse width < 380 μS, Duty Cycle < 2%
 - ③ See MIL-STD-750 Method 3471
 - ④ Starting $T_j = +25^\circ C$, $L = 3.24mH$, $R_G = 25\Omega$, Peak $I_L = 43A$
- APT Reserves the right to change, without notice, the specifications and information contained herein.**

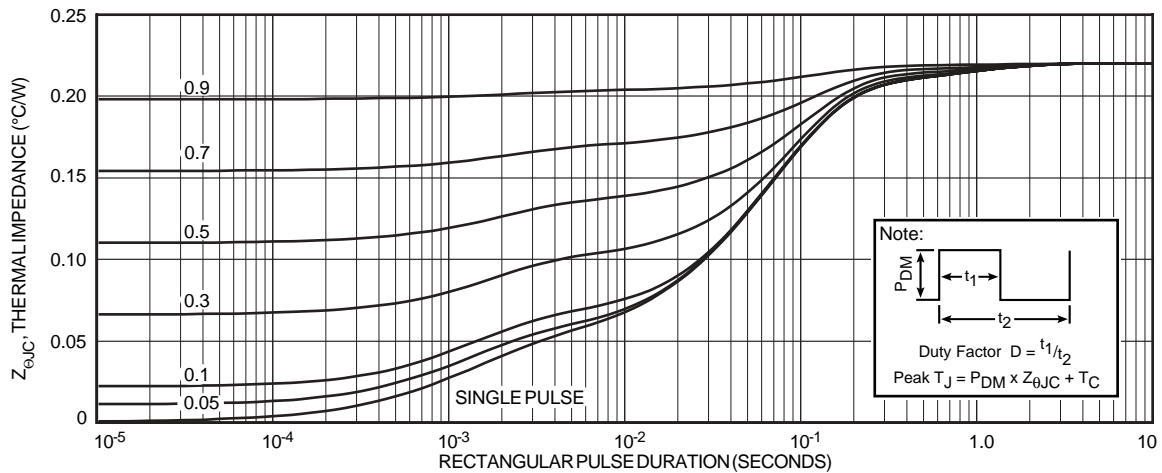

FIGURE 1, MAXIMUM EFFECTIVE TRANSIENT THERMAL IMPEDANCE, JUNCTION-TO-CASE vs PULSE DURATION

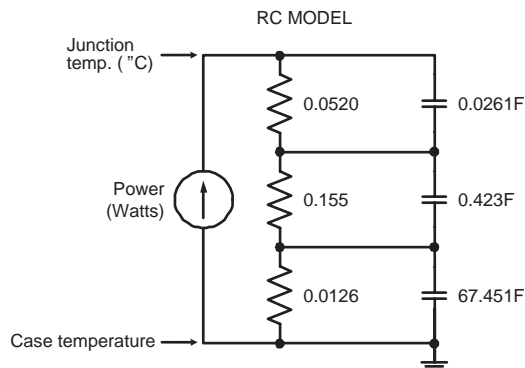
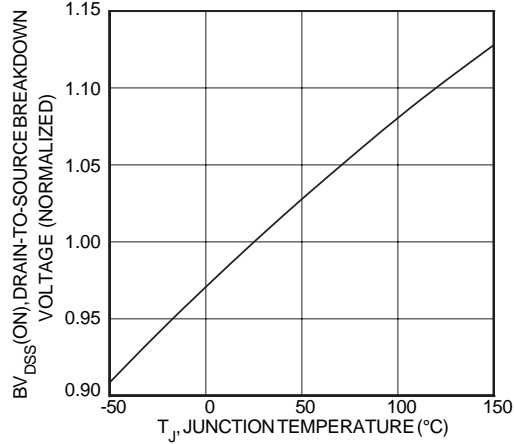
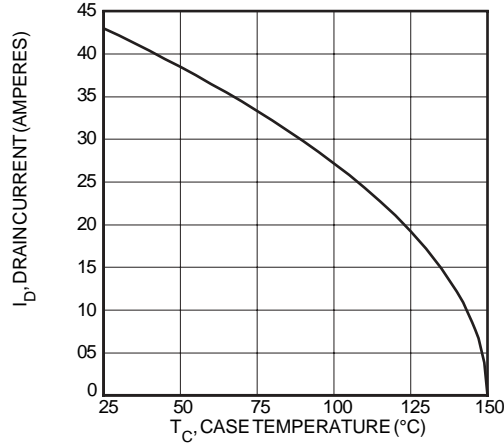
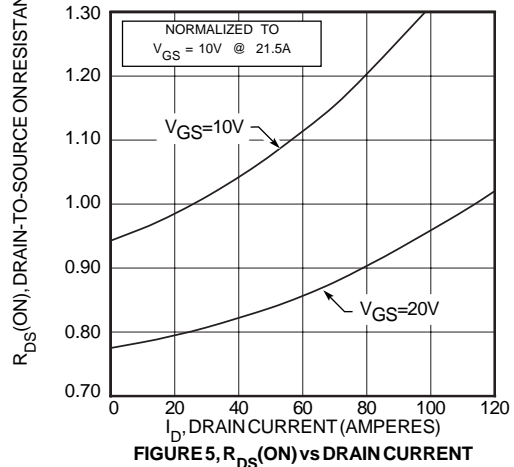
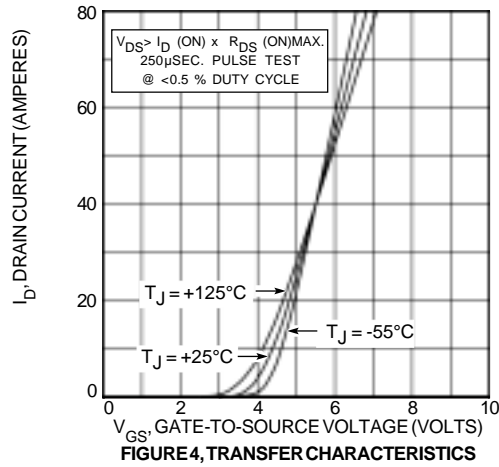
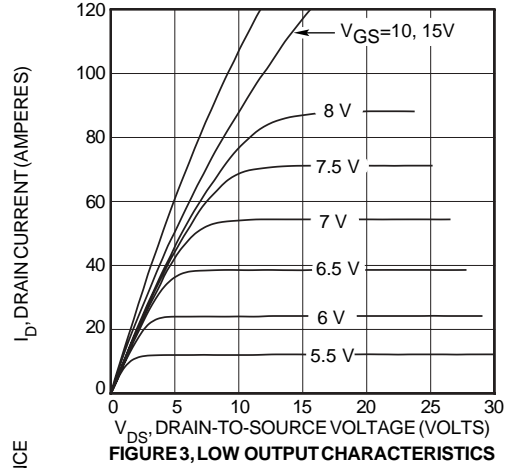
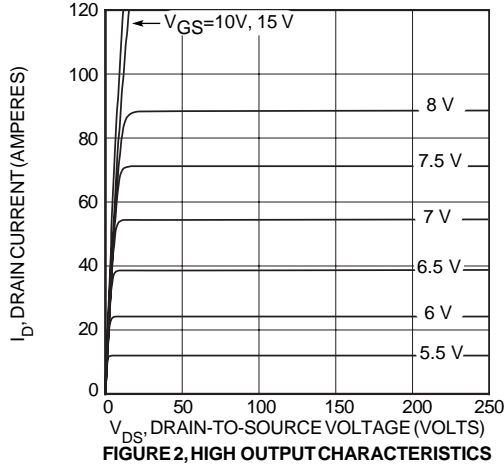

FIGURE 1a, TRANSIENT THERMAL IMPEDANCE MODEL

Typical Performance Curves

APL602J



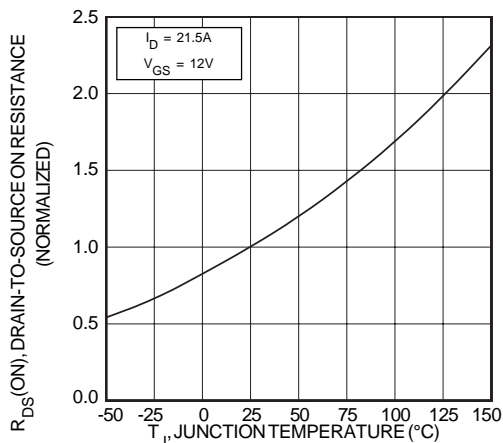

FIGURE 8, ON-RESISTANCE vs. TEMPERATURE

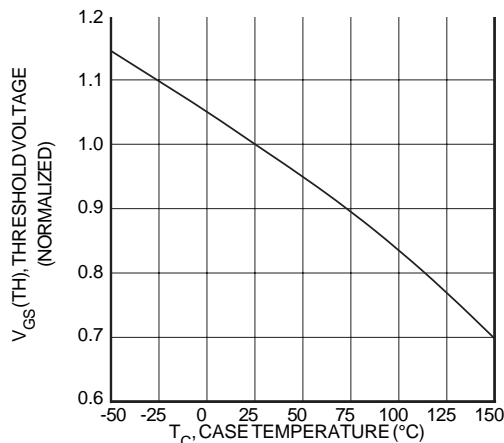

FIGURE 9, THRESHOLD VOLTAGE vs TEMPERATURE

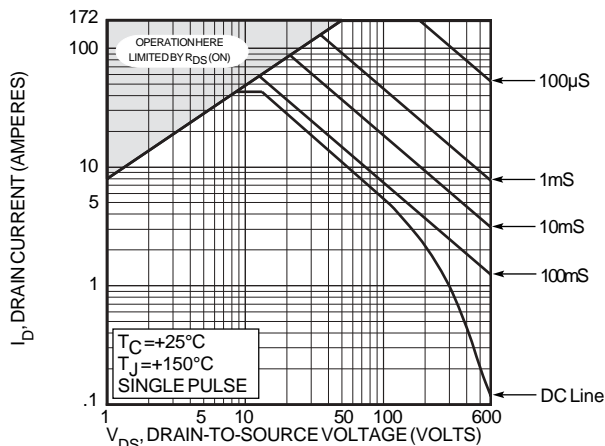

FIGURE 10, MAXIMUM SAFE OPERATING AREA

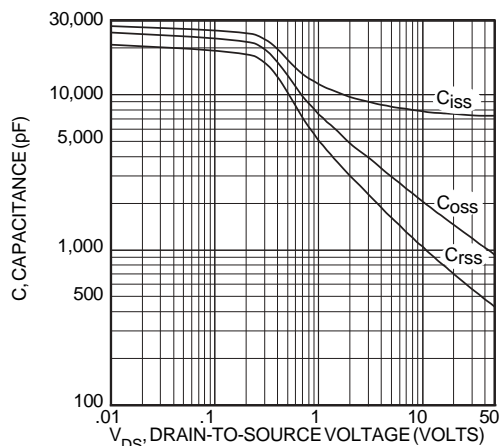
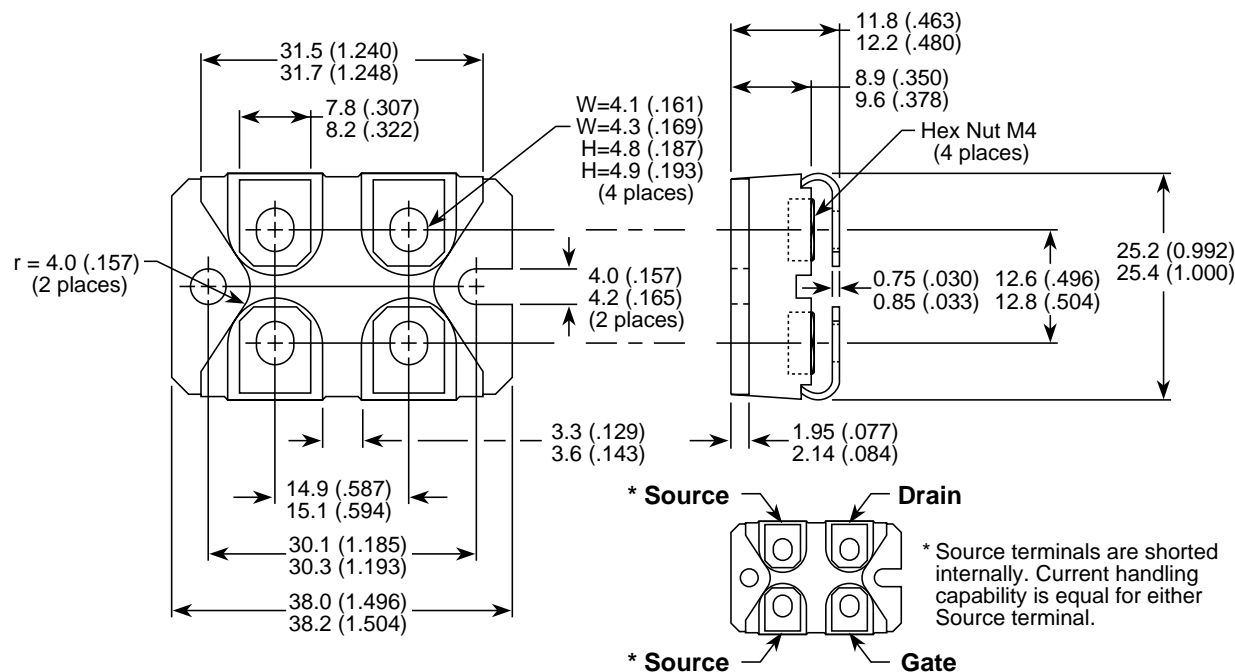

FIGURE 11, CAPACITANCE vs DRAIN-TO-SOURCE VOLTAGE

SOT-227 (ISOTOP®) Package Outline



Dimensions in Millimeters and (Inches)

* Source terminals are shorted internally. Current handling capability is equal for either Source terminal.